

Article number: 20804020

Description: E+G Thrust pad  
DIN 6311-20-S

## Measures

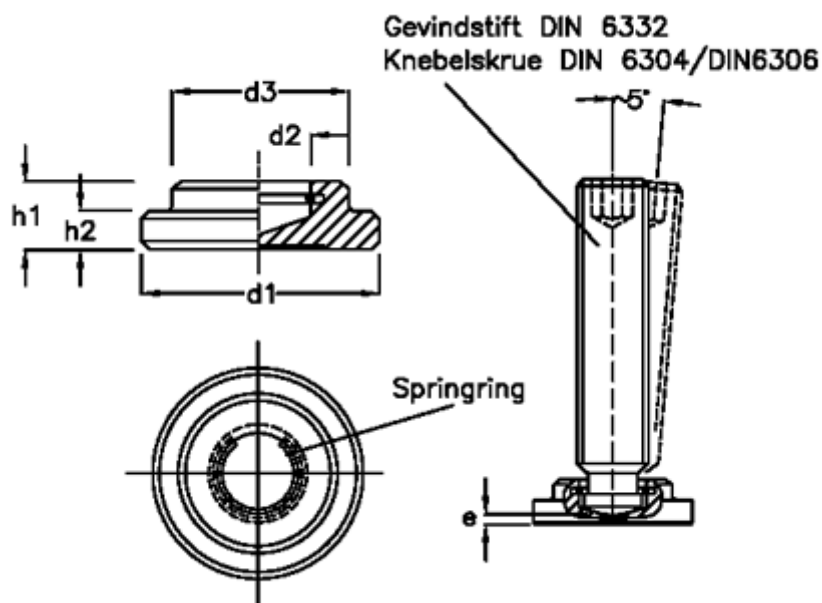

d1 = 20  
d2 = 8.1  
d3 = 15  
e = 3.6  
h1 = 11  
h2 = 5.0  
T = M10